

TIP31G, TIP31AG, TIP31BG, TIP31CG (NPN), TIP32G, TIP32AG, TIP32BG, TIP32CG (PNP)



ON Semiconductor®

<http://onsemi.com>

Complementary Silicon Plastic Power Transistors

Designed for use in general purpose amplifier and switching applications.

Features

- High Current Gain – Bandwidth Product
- Compact TO–220 Package
- These Devices are Pb–Free and are RoHS Compliant*

**3 AMPERE
POWER TRANSISTORS
COMPLEMENTARY SILICON
40–60–80–100 VOLTS,
40 WATTS**

MAXIMUM RATINGS

| Rating | Symbol | Value | Unit |
|---|----------------|-----------------------|--------------------------|
| Collector – Emitter Voltage TIP31G, TIP32G TIP31AG, TIP32AG TIP31BG, TIP32BG TIP31CG, TIP32CG | V_{CEO} | 40 60 80 100 | Vdc |
| Collector–Base Voltage TIP31G, TIP32G TIP31AG, TIP32AG TIP31BG, TIP32BG TIP31CG, TIP32CG | V_{CB} | 40 60 80 100 | Vdc |
| Emitter–Base Voltage | V_{EB} | 5.0 | Vdc |
| Collector Current – Continuous | I_C | 3.0 | Adc |
| Collector Current – Peak | I_{CM} | 5.0 | Adc |
| Base Current | I_B | 1.0 | Adc |
| Total Power Dissipation @ $T_C = 25^\circ\text{C}$ Derate above 25°C | P_D | 40 0.32 | W W/ $^\circ\text{C}$ |
| Total Power Dissipation @ $T_A = 25^\circ\text{C}$ Derate above 25°C | P_D | 2.0 0.016 | W W/ $^\circ\text{C}$ |
| Unclamped Inductive Load Energy (Note 1) | E | 32 | mJ |
| Operating and Storage Junction Temperature Range | T_J, T_{stg} | –65 to +150 | $^\circ\text{C}$ |

Stresses exceeding Maximum Ratings may damage the device. Maximum Ratings are stress ratings only. Functional operation above the Recommended Operating Conditions is not implied. Extended exposure to stresses above the Recommended Operating Conditions may affect device reliability.

1. $I_C = 1.8\text{ A}$, $L = 20\text{ mH}$, P.R.F. = 10 Hz, $V_{CC} = 10\text{ V}$, $R_{BE} = 100\ \Omega$

THERMAL CHARACTERISTICS

| Characteristic | Symbol | Max | Unit |
|---|-----------------|-------|---------------------------|
| Thermal Resistance, Junction–to–Ambient | $R_{\theta JA}$ | 62.5 | $^\circ\text{C}/\text{W}$ |
| Thermal Resistance, Junction–to–Case | $R_{\theta JC}$ | 3.125 | $^\circ\text{C}/\text{W}$ |

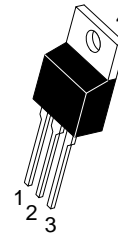
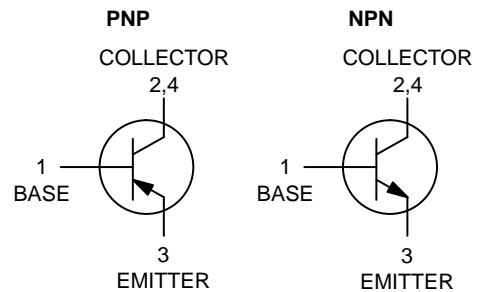

TO-220
CASE 221A
STYLE 1

MARKING DIAGRAM

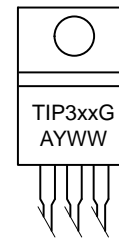

TIP3xx = Device Code
xx = 1, 1A, 1B, 1C,
2, 2A, 2B, 2C,
A = Assembly Location
Y = Year
WW = Work Week
G = Pb–Free Package

ORDERING INFORMATION

See detailed ordering and shipping information in the package dimensions section on page 6 of this data sheet.

*For additional information on our Pb–Free strategy and soldering details, please download the ON Semiconductor Soldering and Mounting Techniques Reference Manual, SOLDERRM/D.

TIP31G, TIP31AG, TIP31BG, TIP31CG (NPN), TIP32G, TIP32AG, TIP32BG, TIP32CG (PNP)

ELECTRICAL CHARACTERISTICS ($T_C = 25^\circ\text{C}$ unless otherwise noted)

| Characteristic | Symbol | Min | Max | Unit |
|---|---------------|-----------------------|--------------------------|-----------------|
| OFF CHARACTERISTICS | | | | |
| Collector–Emitter Sustaining Voltage (Note 2) ($I_C = 30\text{ mA}$, $I_B = 0$) TIP31G, TIP32G TIP31AG, TIP32AG TIP31BG, TIP32BG TIP31CG, TIP32CG | $V_{CE(sus)}$ | 40 60 80 100 | – | Vdc |
| Collector Cutoff Current ($V_{CE} = 30\text{ Vdc}$, $I_B = 0$) TIP31G, TIP32G, TIP31AG, TIP32AG ($V_{CE} = 60\text{ Vdc}$, $I_B = 0$) TIP31BG, TIP31CG, TIP32BG, TIP32CG | I_{CEO} | – | 0.3 0.3 | mAdc |
| Collector Cutoff Current ($V_{CE} = 40\text{ Vdc}$, $V_{EB} = 0$) TIP31G, TIP32G ($V_{CE} = 60\text{ Vdc}$, $V_{EB} = 0$) TIP31AG, TIP32AG ($V_{CE} = 80\text{ Vdc}$, $V_{EB} = 0$) TIP31BG, TIP32BG ($V_{CE} = 100\text{ Vdc}$, $V_{EB} = 0$) TIP31CG, TIP32CG | I_{CES} | – | 200 200 200 200 | μAdc |
| Emitter Cutoff Current ($V_{BE} = 5.0\text{ Vdc}$, $I_C = 0$) | I_{EBO} | – | 1.0 | mAdc |
| ON CHARACTERISTICS (Note 2) | | | | |
| DC Current Gain ($I_C = 1.0\text{ Adc}$, $V_{CE} = 4.0\text{ Vdc}$) ($I_C = 3.0\text{ Adc}$, $V_{CE} = 4.0\text{ Vdc}$) | h_{FE} | 25 10 | – 50 | – |
| Collector–Emitter Saturation Voltage ($I_C = 3.0\text{ Adc}$, $I_B = 375\text{ mA}$) | $V_{CE(sat)}$ | – | 1.2 | Vdc |
| Base–Emitter On Voltage ($I_C = 3.0\text{ Adc}$, $V_{CE} = 4.0\text{ Vdc}$) | $V_{BE(on)}$ | – | 1.8 | Vdc |
| DYNAMIC CHARACTERISTICS | | | | |
| Current–Gain – Bandwidth Product ($I_C = 500\text{ mA}$, $V_{CE} = 10\text{ Vdc}$, $f_{test} = 1.0\text{ MHz}$) | f_T | 3.0 | – | MHz |
| Small–Signal Current Gain ($I_C = 0.5\text{ Adc}$, $V_{CE} = 10\text{ Vdc}$, $f = 1.0\text{ kHz}$) | h_{fe} | 20 | – | – |

2. Pulse Test: Pulse Width $\leq 300\ \mu\text{s}$, Duty Cycle $\leq 2.0\%$.

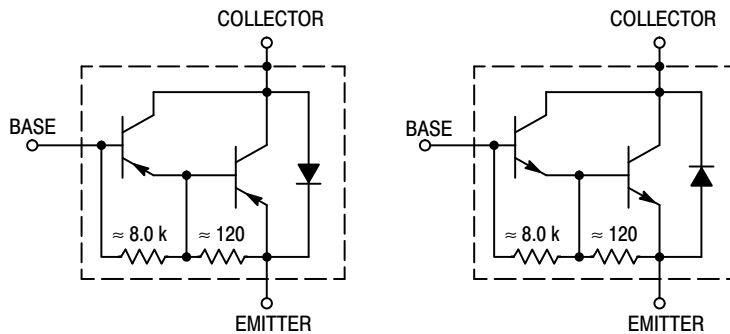

Figure 1. Darlington Circuit Schematic

TIP31G, TIP31AG, TIP31BG, TIP31CG (NPN), TIP32G, TIP32AG, TIP32BG, TIP32CG (PNP)

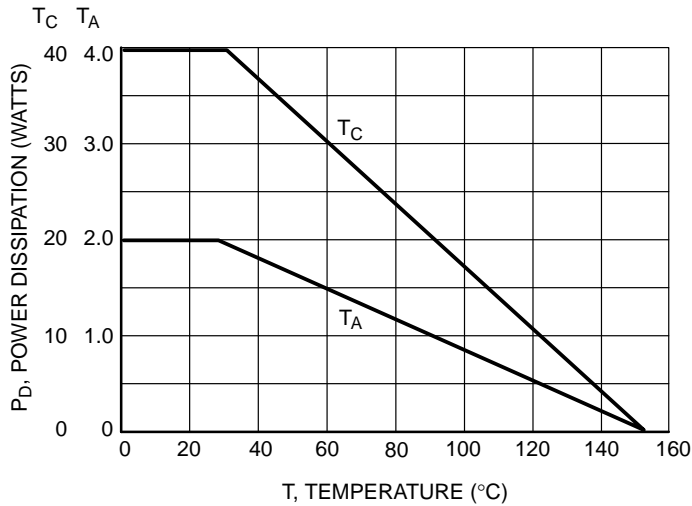
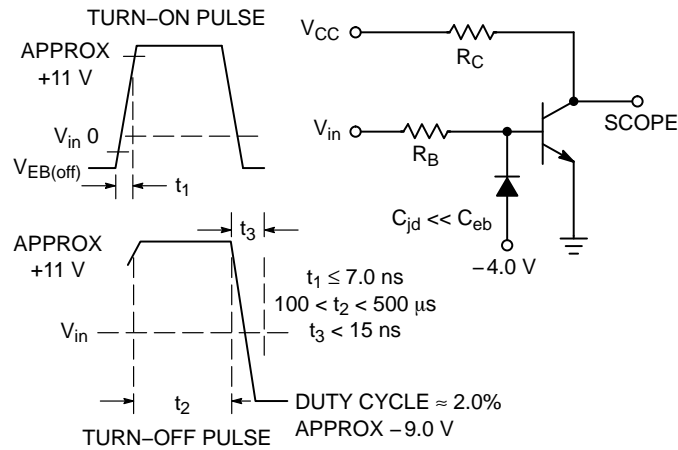

Figure 2. Power Derating



R_B and R_C VARIED TO OBTAIN DESIRED CURRENT LEVELS.

Figure 3. Switching Time Equivalent Circuit

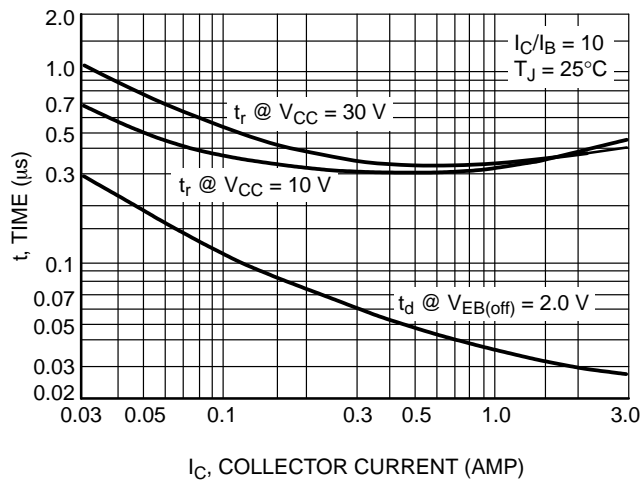

Figure 4. Turn-On Time

TIP31G, TIP31AG, TIP31BG, TIP31CG (NPN), TIP32G, TIP32AG, TIP32BG, TIP32CG (PNP)

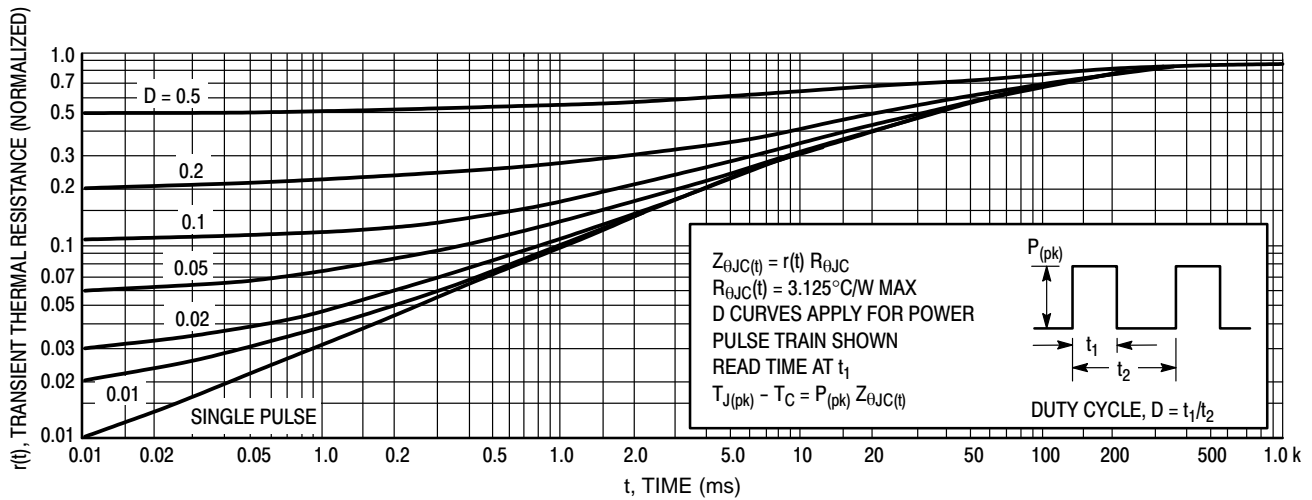

Figure 5. Thermal Response

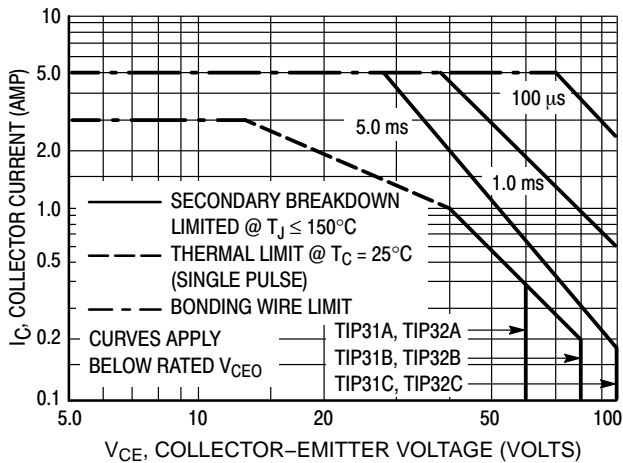

Figure 6. Active Region Safe Operating Area

There are two limitations on the power handling ability of a transistor: average junction temperature and second breakdown. Safe operating area curves indicate $I_C - V_{CE}$ limits of the transistor that must be observed for reliable operation; i.e., the transistor must not be subjected to greater dissipation than the curves indicate.

The data of Figure 6 is based on $T_{J(pk)} = 150^\circ\text{C}$; T_C is variable depending on conditions. Second breakdown pulse limits are valid for duty cycles to 10% provided $T_{J(pk)} \leq 150^\circ\text{C}$. $T_{J(pk)}$ may be calculated from the data in Figure 5. At high case temperatures, thermal limitations will reduce the power that can be handled to values less than the limitations imposed by second breakdown.

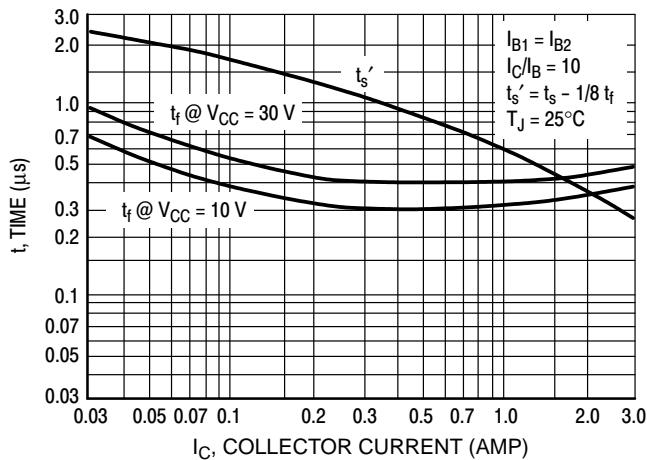

Figure 7. Turn-Off Time

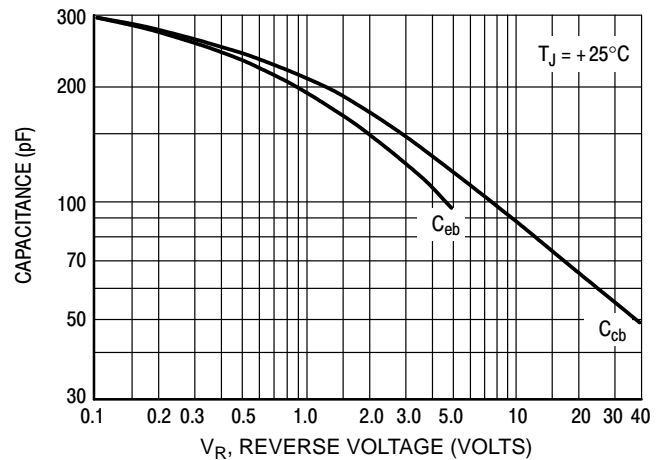

Figure 8. Capacitance

TIP31G, TIP31AG, TIP31BG, TIP31CG (NPN), TIP32G, TIP32AG, TIP32BG, TIP32CG (PNP)

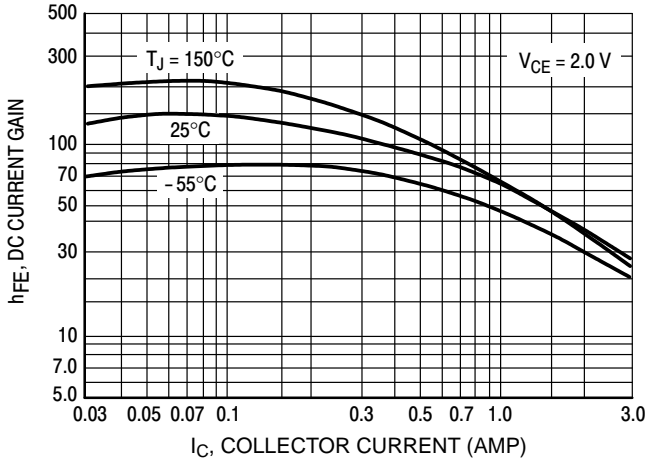

Figure 9. DC Current Gain

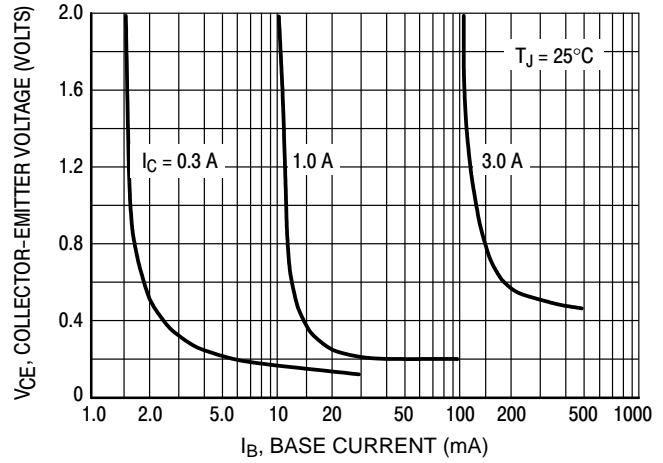

Figure 10. Collector Saturation Region

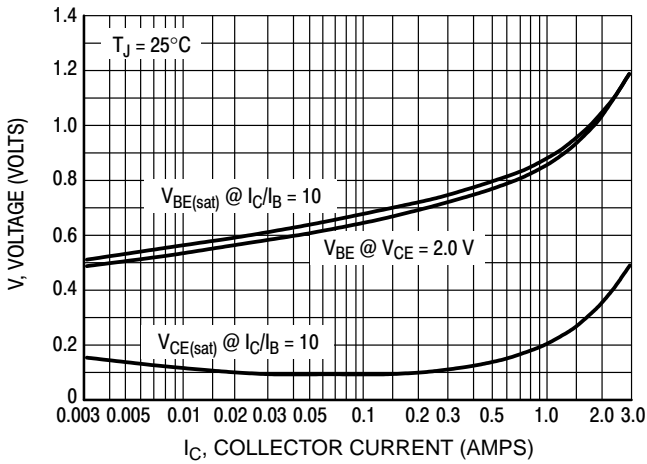

Figure 11. "On" Voltages

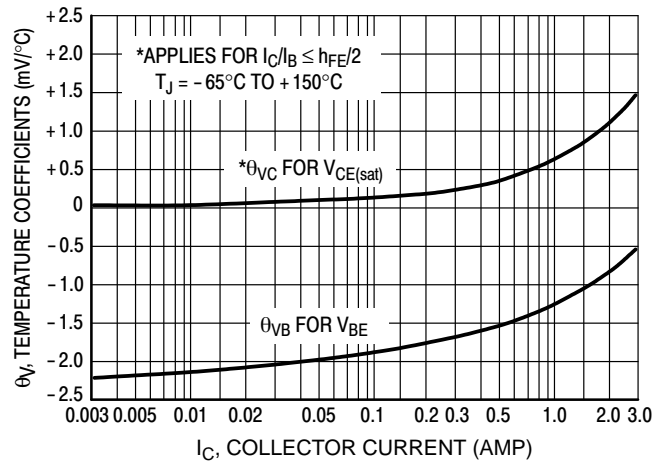

Figure 12. Temperature Coefficients

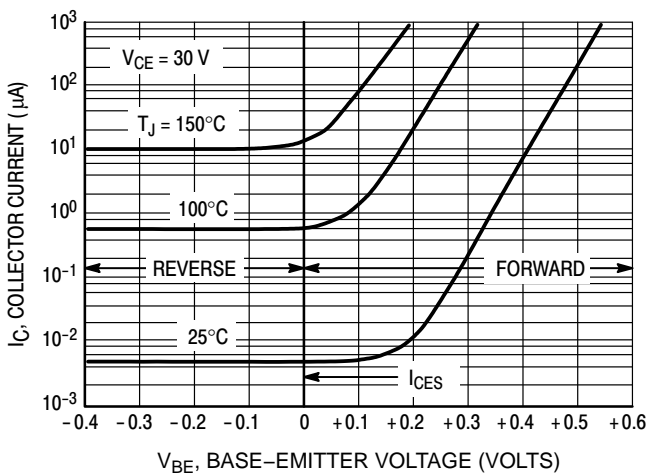

Figure 13. Collector Cut-Off Region

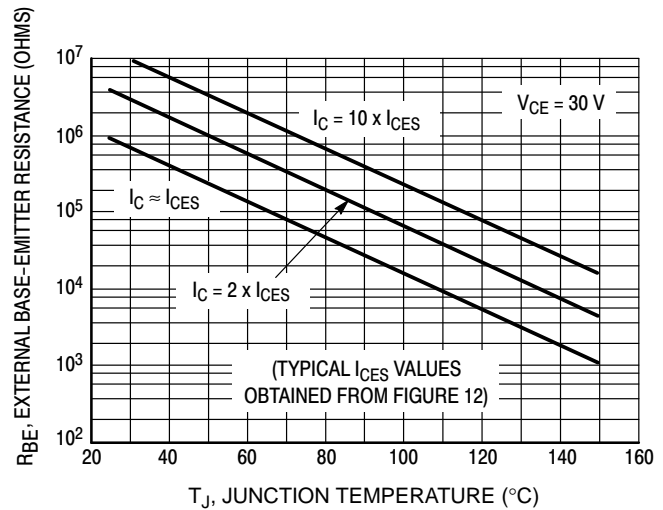

Figure 14. Effects of Base-Emitter Resistance

**TIP31G, TIP31AG, TIP31BG, TIP31CG (NPN), TIP32G, TIP32AG, TIP32BG,
TIP32CG (PNP)**

ORDERING INFORMATION

| Device | Package | Shipping |
|---------------|---------------------|-----------------|
| TIP31G | TO-220 (Pb-Free) | 50 Units / Rail |
| TIP31AG | TO-220 (Pb-Free) | 50 Units / Rail |
| TIP31BG | TO-220 (Pb-Free) | 50 Units / Rail |
| TIP31CG | TO-220 (Pb-Free) | 50 Units / Rail |
| TIP32G | TO-220 (Pb-Free) | 50 Units / Rail |
| TIP32AG | TO-220 (Pb-Free) | 50 Units / Rail |
| TIP32BG | TO-220 (Pb-Free) | 50 Units / Rail |
| TIP32CG | TO-220 (Pb-Free) | 50 Units / Rail |

TIP31G, TIP31AG, TIP31BG, TIP31CG (NPN), TIP32G, TIP32AG, TIP32BG, TIP32CG (PNP)

PACKAGE DIMENSIONS

TO-220
CASE 221A-09
ISSUE AG

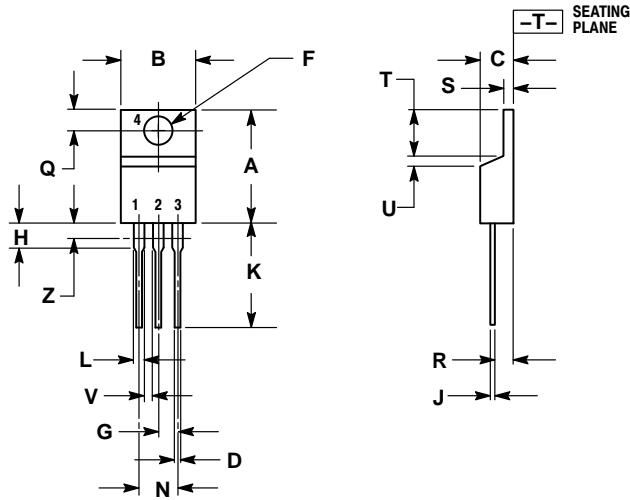

NOTES:

1. DIMENSIONING AND TOLERANCING PER ANSI Y14.5M, 1982.
2. CONTROLLING DIMENSION: INCH.
3. DIMENSION Z DEFINES A ZONE WHERE ALL BODY AND LEAD IRREGULARITIES ARE ALLOWED.

| DIM | INCHES | | MILLIMETERS | |
|-----|--------|-------|-------------|-------|
| | MIN | MAX | MIN | MAX |
| A | 0.570 | 0.620 | 14.48 | 15.75 |
| B | 0.380 | 0.405 | 9.66 | 10.28 |
| C | 0.160 | 0.190 | 4.07 | 4.82 |
| D | 0.025 | 0.036 | 0.64 | 0.91 |
| F | 0.142 | 0.161 | 3.61 | 4.09 |
| G | 0.095 | 0.105 | 2.42 | 2.66 |
| H | 0.110 | 0.161 | 2.80 | 4.10 |
| J | 0.014 | 0.025 | 0.36 | 0.64 |
| K | 0.500 | 0.562 | 12.70 | 14.27 |
| L | 0.045 | 0.060 | 1.15 | 1.52 |
| N | 0.190 | 0.210 | 4.83 | 5.33 |
| Q | 0.100 | 0.120 | 2.54 | 3.04 |
| R | 0.080 | 0.110 | 2.04 | 2.79 |
| S | 0.045 | 0.055 | 1.15 | 1.39 |
| T | 0.235 | 0.255 | 5.97 | 6.47 |
| U | 0.000 | 0.050 | 0.00 | 1.27 |
| V | 0.045 | --- | 1.15 | --- |
| Z | --- | 0.080 | --- | 2.04 |

STYLE 1:

- PIN 1: BASE
2. COLLECTOR
3. EMITTER
4. COLLECTOR

ON Semiconductor and are registered trademarks of Semiconductor Components Industries, LLC (SCILLC). SCILLC owns the rights to a number of patents, trademarks, copyrights, trade secrets, and other intellectual property. A listing of SCILLC's product/patent coverage may be accessed at www.onsemi.com/site/pdf/Patent-Marking.pdf. SCILLC reserves the right to make changes without further notice to any products herein. SCILLC makes no warranty, representation or guarantee regarding the suitability of its products for any particular purpose, nor does SCILLC assume any liability arising out of the application or use of any product or circuit, and specifically disclaims any and all liability, including without limitation special, consequential or incidental damages. "Typical" parameters which may be provided in SCILLC data sheets and/or specifications can and do vary in different applications and actual performance may vary over time. All operating parameters, including "Typicals" must be validated for each customer application by customer's technical experts. SCILLC does not convey any license under its patent rights nor the rights of others. SCILLC products are not designed, intended, or authorized for use as components in systems intended for surgical implant into the body, or other applications intended to support or sustain life, or for any other application in which the failure of the SCILLC product could create a situation where personal injury or death may occur. Should Buyer purchase or use SCILLC products for any such unintended or unauthorized application, Buyer shall indemnify and hold SCILLC and its officers, employees, subsidiaries, affiliates, and distributors harmless against all claims, costs, damages, and expenses, and reasonable attorney fees arising out of, directly or indirectly, any claim of personal injury or death associated with such unintended or unauthorized use, even if such claim alleges that SCILLC was negligent regarding the design or manufacture of the part. SCILLC is an Equal Opportunity/Affirmative Action Employer. This literature is subject to all applicable copyright laws and is not for resale in any manner.

PUBLICATION ORDERING INFORMATION

LITERATURE FULFILLMENT:

Literature Distribution Center for ON Semiconductor
P.O. Box 5163, Denver, Colorado 80217 USA
Phone: 303-675-2175 or 800-344-3860 Toll Free USA/Canada
Fax: 303-675-2176 or 800-344-3867 Toll Free USA/Canada
Email: orderlit@onsemi.com

N. American Technical Support: 800-282-9855 Toll Free
USA/Canada
Europe, Middle East and Africa Technical Support:
Phone: 421 33 790 2910
Japan Customer Focus Center
Phone: 81-3-5817-1050

ON Semiconductor Website: www.onsemi.com

Order Literature: <http://www.onsemi.com/orderlit>

For additional information, please contact your local Sales Representative

Mouser Electronics

Authorized Distributor

Click to View Pricing, Inventory, Delivery & Lifecycle Information:

[ON Semiconductor:](#)

[TIP31AG](#) [TIP31BG](#) [TIP31CG](#) [TIP31G](#) [TIP32AG](#) [TIP32BG](#) [TIP32CG](#) [TIP32G](#)